

WORLD CLASS WINCHES

RELIABLE – DEPENDABLE – UNCOMPLICATED



SEPDURANCE H300

Rope "under wound"

Technical Data

Freespool clutch

Max. pulling force in low speed mode*

- bottom rope layer
- top rope layer

Max. rope speed in low speed mode*

- bottom rope layer
- top rope layer

Maximum rope speed in high speed mode

- bottom rope layer
- top rope layer

Maximum oil pressure

Maximum oil flow

Rope drum diameter

Rope diameter

Rope length

Rope MBL (EN 14492-1)

Number of rope layers

Winch weight

Rope weight

Dimensional drawing (mm)

Product # 63.53-053

Pneumatic

300 kN
190 kN

2.0 m/min
3.5 m/min

6 m/min
10 m/min

200 bar
70 l/min

234 mm
26 mm
60 m
≥ 600 kN
4

520 kg
197 kg

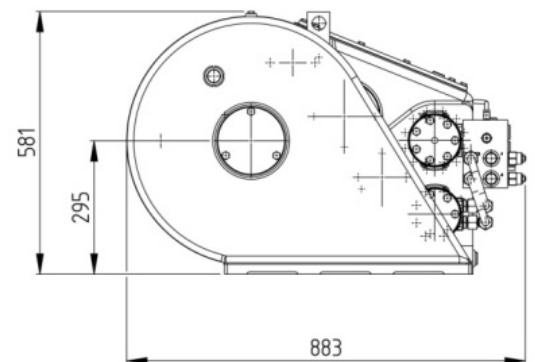
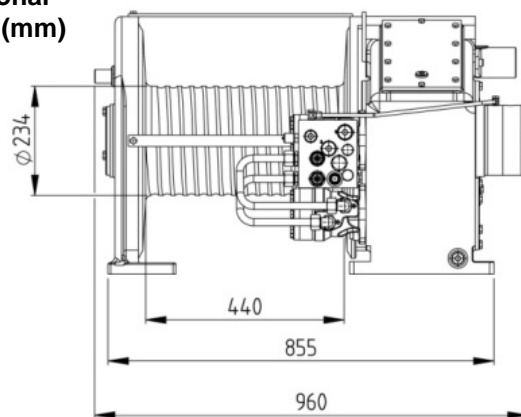

Compliant to EN 14492-1

