

WORLD CLASS WINCHES

RELIABLE – DEPENDABLE – UNCOMPLICATED



SEPDURANCE H70S

Technical Data

Freespool clutch

Max. pulling force

- bottom rope layer
- top rope layer

Max. rope speed

- bottom rope layer
- top rope layer

Maximum oil pressure

Maximum oil flow

Rope drum diameter

Rope diameter

Rope length

Rope MBL (EN 14492-1)

Number of rope layers

Winch weight

Rope weight

Dimensional drawing (mm)

Product # 63.31-015

Pneumatic

70 kN
45 kN

8 m/min
12 m/min

160 bar
60 l/min

224 mm
16 mm
60 m
≥ 140 kN
5

197 kg
67 kg

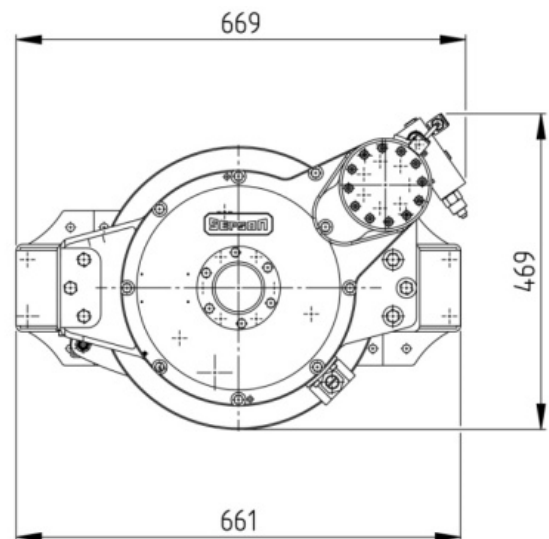
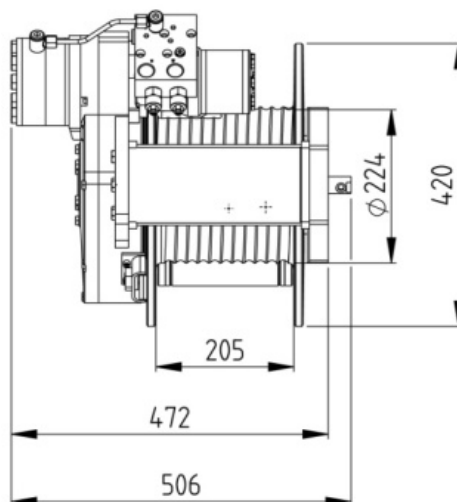

Compliant to EN 14492-1

